

High Standard, Reliable Strength

Tested in the toughest conditions to achieve reliable durability and strength. REWARD meets your needs with its toughness even in scorching desert.

معايير عالية، قوة موثوقة

تم اختبارها في أشد الظروف قسوة لتضمن صلابة وقوة جديرة بالثقة. تلبية REWARD احتياجاتك بصلابتها حتى في الصحراء الحارقة.

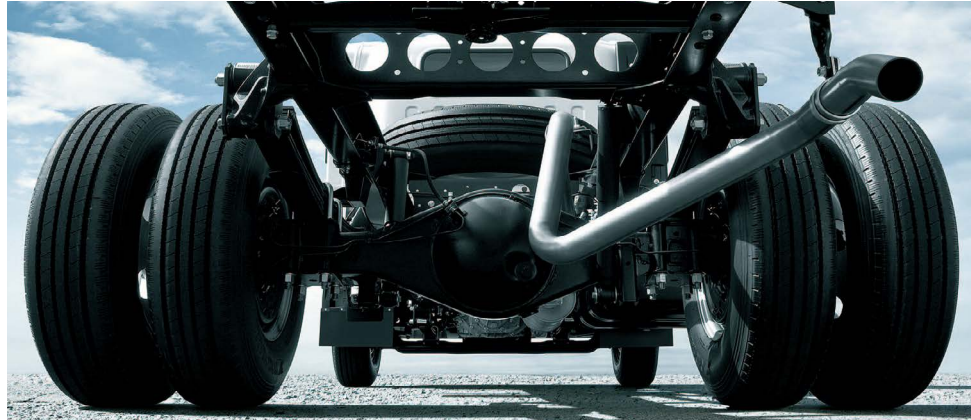

Outstanding axle capacity

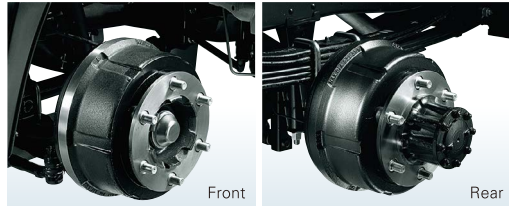

Reliable wide drum brake

Image of operation with an anti-lock brake system

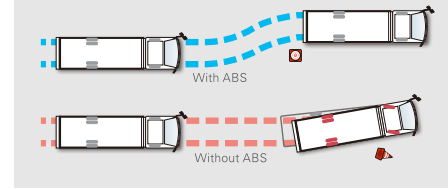

ABS is standard for all model



Durable high tensile steel frame

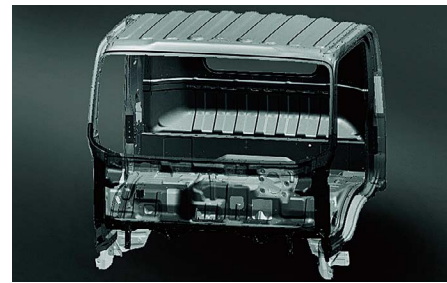

Light weight strong cab structure

VARIATION

STANDARD CAB (width: 1,815mm)



WIDE CAB (width: 2,040mm)



EXTERIOR COLOR



ARC WHITE

Applications

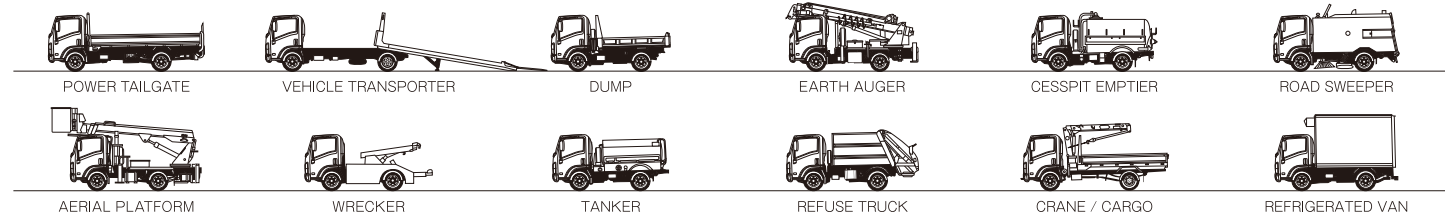

Trucks for life
ISUZU

Trucks for life
ISUZU

N-SERIES REWARD

Light-Duty Trucks GVW 4.55-9.5ton



REWARD Specification

مواصفات REWARD

MODEL	الموديل	NLR77E	NMR77H	NMR85E	NMR85H	NMR85H	NPR81H	NPR81H	NPR81K	NPR75F	NPR75K	NPR75L	NQR90K	NQR90L
REAR TIRE	الإطارات الخلفية	Single	Dual											
CAB	هيكل	Standard Single	Standard Crew	Standard Single		Standard Crew	Wide Single	Wide Crew	Wide Single	Wide Single				
APPLICATION*	التطبيقات*	—	Flat Bed	Dump	Flat Bed			Dump	Flat Bed	—	—	—	—	—
GVW (t)	وزن الشاحنة بكامل الحمولة (طن)	4.55	5.2				6.5			7.5			9.5	
CHASSIS MASS ** (t)	وزن الهيكل ** (طن)	1.81	2.29	2.03	2.13	2.33	2.63	2.82	2.69	2.56	2.75	2.8	2.92	2.95
AXLE CAPACITY Front / Rear (t)	استطاعة الحمل للمحور أمامي / خلفي (طن)	2.9 / 3.6	2.9 / 5.0				3.1 / 5.0			3.1 / 6.6				
ENGINE/EXHAUST	المحرك/ العادم	4JH1-TC / 2,999cc		4JJ1-TC / 2,999cc			4HL1-TCN / 4,778cc			4HK1-TCN / 5,193cc				
POWER	القدرة	105ps (77kw) / 3,200		130ps (96kw) / 2,800			130ps (96kw) / 2,600			150ps (110kw) / 2,600				
TORQUE	العزم	23.5kg·m (230N·m) / 1,400 - 3,200		34kg·m (330N·m) / 1,600 - 2,600			38kg·m (375N·m) / 1,100 - 2,350			41kg·m (404N·m) / 1,500 - 2,600				
T / M	ناقل الحركة	MSB-5S 5-speed		MYJ-5T 5-speed			MYY-6S 6-speed							
BRAKE ASSIST	نظام مساعدة الفرامل	Vacuum with ABS	Vacuum with ABS and Exhaust Brake				Hydro Brake Booster with ABS and Exhaust Brake					Full Air with ABS and Exhaust Brake		
TIRE	الإطارات	205 / 85R16		195 / 85R16		205 / 85R16	215 / 75R17.5							
OAL (mm)		4,730	6,020	4,730	6,020	6,030	5,985	6,635	5,385	6,635	7,355	6,635	7,355	
OW (mm)		1,815					2,040							
WB (mm)		2,475	3,345	2,475	3,345		3,365	3,815	2,765	3,815	4,175	3,815	4,175	
FOH (mm)		1,110												
ROH (mm)		1,145	1,565	1,145	1,565	1,575	1,510	1,710	1,510	1,710	2,070	1,710	2,070	
CA (mm)		2,022	1,781	2,022	2,892	1,781	2,792	1,801	3,242	2,192	3,242	3,602	3,242	3,602
CE (mm)		3,167	3,346	3,167	4,457	3,356	4,302	3,311	4,952	3,702	4,952	5,672	4,952	5,672
OH (mm)		2,185	2,235	2,185			2,275			2,285			2,280	

* Application is optional. ** Exclude application weight.

Meets Any Business Needs

Designed with functional beauty and customization to fulfill any job.

تلبى أي متطلبات للعمل

مُصممة بجمال وظيفي وقدرة على الضبط حسب الطلب لتنفيذ أي مهمة.



Fully featured workspace



Cabin space is the widest in the class



Wide rear seat for crew cab model



6 DIN space



Visible LED meter



Exhaust brake



Easy hand movement panel

World-renowned ISUZU Engine

The world renowned ISUZU diesel engine with improved power, durability, and fuel efficiency will lead your business to the next stage.

محرك إيسوزو المشهور عالمياً

سوف يقود محرك الديزل لإيسوزو ذو الشهرة العالمية مع تحسينات في القدرة والمتانة وكفاءة استهلاك الوقود أعمالك إلى المرحلة التالية.

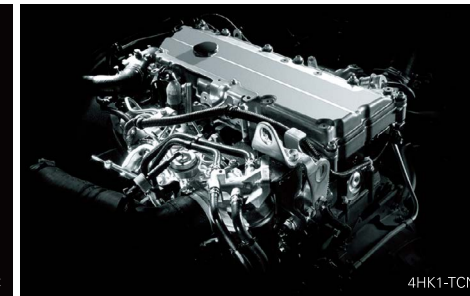

4JJ1-TC

Direct-injection DOHC intercooled turbo

- Displacement 2,999cc
- Max. Output 96kW (130PS)/2,800rpm
- Max. Torque 330N·m (34.0kg·m)/1,600 - 2,600rpm

4JH1-TC

Direct-injection DOHC intercooled turbo

- Displacement 2,999cc
- Max. Output 77kW (105PS)/3,200rpm
- Max. Torque 230N·m (25.5kg·m)/1,400 - 3,200rpm

4HK1-TCN

Direct-injection OHC intercooled turbo

- Displacement 5,193cc
- Max. Output 110kW (150PS)/2,600rpm
- Max. Torque 404N·m (41.0kg·m)/1,500 - 2,600rpm

4HL1-TCN

Direct-injection OHC intercooled turbo

- Displacement 4,778cc
- Max. Output 96kW (130PS)/2,600rpm
- Max. Torque 375N·m (38.0kg·m)/1,100 - 2,350rpm

Dimension Reference

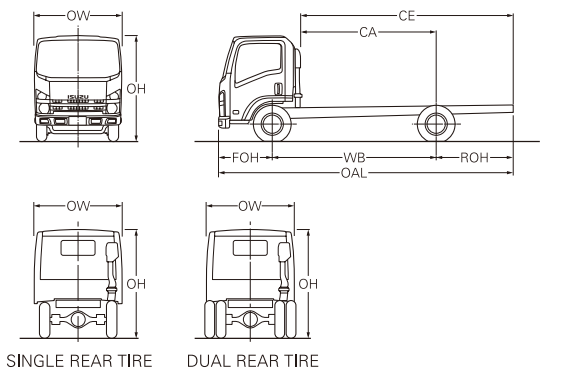

SINGLE REAR TIRE

DUAL REAR TIRE